

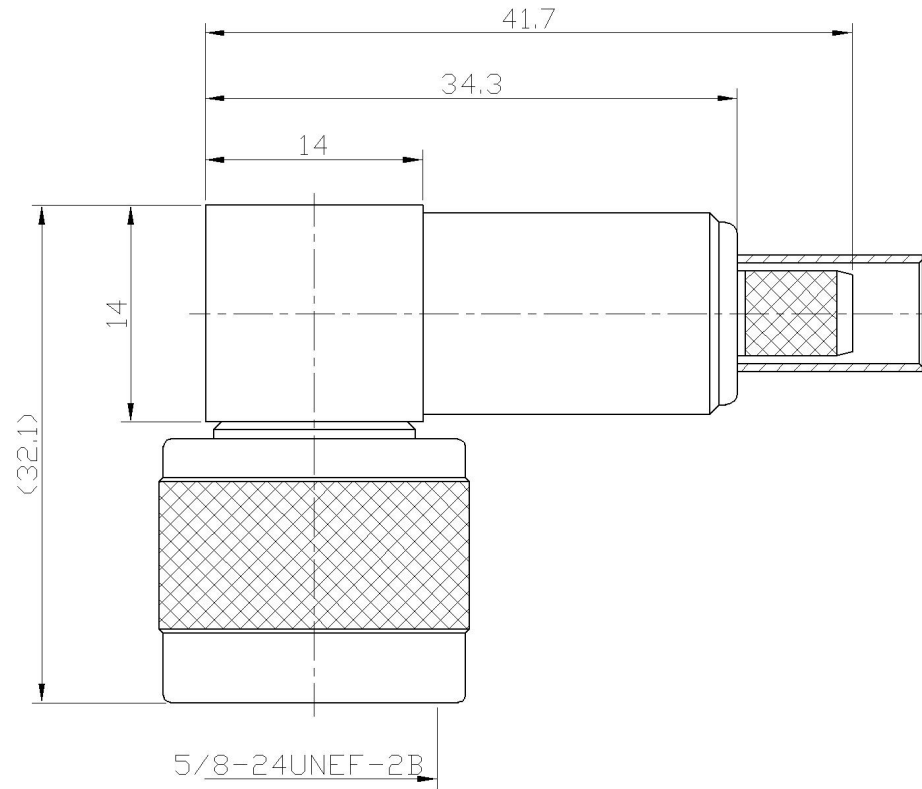

RevNo	Revision note	Date	Signature	Checked
V1.0	Sketch only			

RoHS Compliant.



材料与电镀 Materials&Electroplating	
内导体 Conduct	黄铜/镀金 Brass/Gold Plating
介质 Insulator	聚四氟乙烯 PTFE
外壳 Body	黄铜/镀镍 Brass/Nickel Plating
其他零件 Other Parts	黄铜/镀镍 Brass/Nickel Plating
电气性能 Electric Performance	
阻抗 Impedance	50 欧姆 50 Ohms
频率范围 Frequency Range	0~3Ghz
驻波比 VSWR	1.3
额定电压 Rating Voltage	350VAC

Unless otherwise specified, tolerances as below: .x ±0.15 .xx ±0.1 .xxx ±0.05 Angle: ±2°	Material:	See Notes	Weight	-	 Lenor 乐福士
	Finish:	See Notes	Scale	-	
	Unit	mm	Page	01	
	REV.	V1.0	DWG No	-	P/N 料号
Drawn	Date:	Projection		Cust P/N.	
Checked	Date:	Title:			
Approved	Date:	品名 N PLUG RIGHT ANGLE CRIMP FOR LMR240 CABLE			