

Specification

LenoRF

Product Name	2.4mm Connector Jack Flange Solder For Microstrip	Part No	2.92-KFD31G
--------------	---	---------	-------------

Dimension:

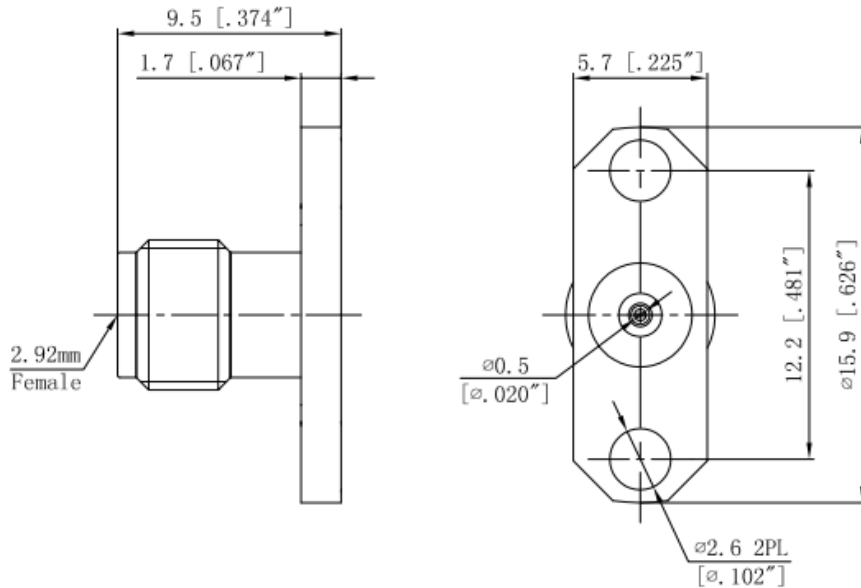

Electric Parameter

Impedance	50Ω
Insulation resistance	≥5000MΩ
Test Voltage	1000V
Temperature range	-55°C~+165°C
Frequency Range	DC~40GHz
VSWR	≤1.25:1
Durability	500 times

Materials & Plating

	Material	Plating
Body	Stainless Steel	Passivation
Insulator	PEI	
Contact	CuBe	Gold